

SILVERLINE

Dusk 100cm Ceiling Hood



Installation & User Instructions

**Please read these instructions carefully before installing
and operating this appliance**

Contents

1. Introduction	3
2. Health and Safety	3-4
3. Warranty Information	4-5
3.1 After Sales Service Information	4
3.2 How to Report a Fault	5
3.3 Technical Assistance	5
4. Installation	5-20
4.1 Assembly Instructions	5-6
4.2 Ducting Options	6
4.3 Motor Options	6-7
4.4 Ducting & Recirculation	7-8
4.4.1 Instructions for Circulating Air Mode	8
4.5 Recommendations Depending on the Building Standard and Building Equipment	9-12
4.6 Special Features for Energy-Efficient Buildings	13-14
4.6.1 Recommendations for Buildings with Very Low Heating Requirements	14
4.7 Ducting	15
4.7.1 Information on Exhaust Air Ducting	15
4.7.2 Cross Section of the Exhaust Air Ducting	15
4.7.3 Exhaust Material, Ducting & Shape	16
4.7.4 Length of the Exhaust Ducting, Curves & Bends	17-18
4.8 Electrical Wiring	19-20
4.8.1 Electrical Wiring Diagram	19
4.8.2 Controls	20
5. Use & Maintenance	20
5.1 Changing the Light Bulbs	20
5.2 Cleaning the Metal Filters	20
5.3 Cleaning the Hood	20
6. Technical Data	21
7. Dimensions	21-23
7.1 Dusk 100cm Ceiling Hood	21-22
7.2 1240 T1 Motor	22
7.3 1250 T2 Motor	23
7.4 1270 T3 External Motor	23
8. Troubleshooting	24

1. Introduction

Dear Customer,



We wish to thank you for choosing this Air Uno cooker hood. In order to get the best performance from your appliance we recommend that you read this booklet carefully before operating the appliance for the first time.

Revisions to the publication

In order to improve the product, to keep this publication up to date the manufacturer reserves the right to make modification without any advance notice. Any reproduction, even in part, of this manual without the consent of the manufacturer is prohibited.

Care of the manual and how to consult it

- Take good care of this manual and keep it in a place which can be easily and quickly reached.
- If this manual should be lost or destroyed, or if it is in poor condition, ask for a copy from your retailer, providing product identification data.
- Information which is essential or that requires special attention is shown in bold text.

	<p>ATTENTION This warning sign indicates that the message to which it refers should be carefully read and understood, because failure to comply with what these notices say can cause serious damage to the extractor and put the user's safety at risk.</p>
	<p>INFORMATION This symbol is used to highlight information which is important for proper extractor operation. Failure to comply with these provisions will compromise use of the boiler and its operation will not be satisfactory.</p>
	<p>MANUAL Indicates that you should carefully read this manual or the related instructions.</p>

2. Health and Safety



- **Installation of the cooker hood, making electrical connections, checking its operation and maintenance are all tasks which should be carried out by qualified and authorised personnel.**

- **Install the cooker hood in accordance with the regulations in force in your local area, region and country.**
- For the correct use of the appliance and to prevent accidents, the instructions given in this booklet must always be followed.
- Before beginning any operation, the user, or whoever is preparing to operate on the appliance, must have read and understood the entire contents of this instruction booklet.
- All responsibility for improper use is taken entirely by the user and as such relieves Air Uno of any civil or criminal responsibility.
- In view of the fact that it is an electrical appliance, do not touch the appliance with wet hands.
- Before carrying out any cleaning or maintenance operation, make sure in advance that the appliance is isolated from the mains electricity supply.
- Incorrect installation or faulty maintenance (not conforming to the requirements set out in this booklet) can cause harm to people, animals or property. In such cases Air Uno is absolved from any civil or criminal responsibility.

This product complies with EU Directive EU2002/96/EC.

The crossed bin symbol on the appliance indicates that the product, at the end of its life, must be disposed of separately from domestic waste, either by taking it to a separate waste disposal site for electric and electronic appliances or by returning it to your dealer when you buy another similar appliance. The user is responsible for taking the appliance to a special waste disposal site at the end of its life. If the disused appliance is collected correctly as separate waste, it can be recycled, treated and disposed of ecologically.

WARNINGS:

- This appliance can be used by children aged from 8 years and above and persons with reduced physical, sensory or mental capabilities, or lack of experience and knowledge if they have been given supervision or instruction concerning use of the appliance in a safe way and understand the hazards involved.
- Children shall not play with the appliance. Cleaning and user maintenance shall not be made by children without supervision.

- Before cleaning or performing any periodic or urgent maintenance to the hood, isolate the mains supply and turn the main switch off.
- Do not connect the hood to any piping used for combustion appliances, such as burners, boilers or fire places.
- Check that the main power supply corresponds to the voltage required by the hood, which is given on the silver label stuck inside the hood. Ensure that the electric system is correctly earthed and that the earth discharge works correctly.
- When cooking do not use any materials that could form high or unusual flames. Oil that has been used twice and fats are very dangerous and could easily catch fire. Do not prepare flambé dishes under the hood.
- Once the specialised technician has completed the installation of the hood equipped with a remote motor, all the leads, connectors, ground connections and the remote motor must not be accessible to the user. Only the installer is granted access by removing screwed on panel.
- Respect local legislation and regulations issued by the relative authorities regarding the exhaust air when the suction is operating. Failure to respect and perform all maintenance and cleaning operations described in this handbook could cause a fire hazard.



ATTENTION: Accessible parts may become hot when the hood is used with cooking appliance.

3. Warranty Information

We offer a 5 year warranty on all Silverline cooker hoods, which will start from the date of delivery. The warranty covers parts and labour for the 4 year term based on whether its proved to be either faulty materials or components. We will at our own discretion either repair or replace the goods Free of Charge, including any carriage costs.

This is based on the following conditions:-

1. The product has been fitted/installed as per our instructions.
2. The product has been used for normal domestic purposes only, and in accordance with the

manufacturer's operating and maintenance instructions.

3. The product has been serviced, maintained, repaired, taken apart or tampered with by any person not authorised by us.

EXCLUSIONS

This guarantee does not cover:

- Damage or calls resulting from incorrect installation, transportation, improper use or neglect, the replacement of any light bulbs or removable parts of glass or plastic.
- Costs incurred for calls to put right appliances improperly installed or calls to appliances outside the United Kingdom.
- Normal wear and tear.
- Products deemed to be in use within a commercial environment.
- Grease filter mesh.
- Bulbs and LEDs.
- Carbon filters.
- Damage caused to the body by usage of detergent spray or other contaminants.
- Damage or corrosion of the LED pars, glass and stainless steel parts.
- Any products taken apart or serviced by unauthorised individuals or service engineers or replaced with other manufacturer's components.
- Product which is not installed with the correct size ducting.

This guarantee is in addition to your statutory and legal rights.

3.1 After Sales Service Information

A field service engineer is available to attend a breakdown occurring during the cooker hoods guarantee period.

The cooker hood must be made available for attendance during normal working hours, Monday to Friday.

3.2 How to Report a Fault

Step 1

- Contact your installation or service engineer, who should assess the unit and works carried out on the appliance prior to requesting the attendance of an engineer from Silverline.

Step 2

Please note that upon attendance by an Silverline engineer, a charge will be made where: - The engineer finds no fault with the cooker hood.

- The cause of the breakdown is due to parts of the system not manufactured or supplied by Silverline.
- The cooker hood has not been installed in accordance with the manufacturer's instructions.
- The cooker hood has not been installed by a qualified fitter.
- The breakdown occurs outside the guarantee period.
- The appliance has not been maintained correctly.
- The breakdown occurs as a result of work on the appliance by an unauthorised third-party.

3.3 Technical Assistance

A team of trained technical advisors are available to discuss any problem with the appliance. In many cases, the problem may be solved over the telephone, eliminating the need for an engineer's visit. Before making contact, please have the following information ready:

- The details of the Silver label (located on the inside of the cooker hood behind the grease filters).
- A description of the fault and any unusual behaviour by the cooker hood before the failure occurred.
- The installation date.

Silver label details

MODEL: _____
SERIAL _____
NUMBER: _____
Installation Date: _____

4. Installation

The minimum safety distance between the bottom of the hood and the top of the cooking hob must be 650mm, smaller distances must be previously authorised by the manufacturer. The maximum is 1.6m.

When the suction function is operating i.e. exhausting the filtered air on the outside, a suitable compensation system must be used according to current standards in force. The diameter of the fume exhaust pipe must be the same or greater than the diameter of the hood pipe union.

There must be sufficient ventilation in the room where the hood is installed, to allow simultaneous use of other appliances that use gas or other fuels.

4.1 Assembly Instructions

Attention: Before proceeding with the installation, make sure that the screws and the anchors supplied, are suitable for the type of wall/ceiling the hood will be fixed to.

To assemble the hood use the accessories that are supplied and follow the instructions given in the enclosed hand book.

Screw hole dimensions

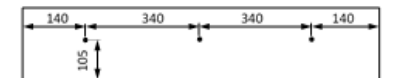

Fig 1



Fig 2

Cut-out dimensions

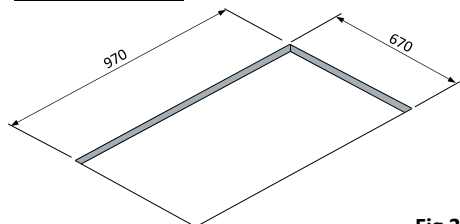

Fig 3

1. Open the 2 panels to reveal the grease filters (Fig 4).

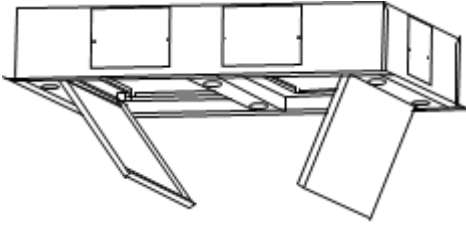

Fig 4

2. Remove the grease filters (Fig 5).

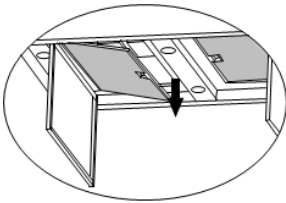

Fig 5

3. Hold the hood up into the cut-out in the ceiling and fix the hood at the fixing points (Fig 6).

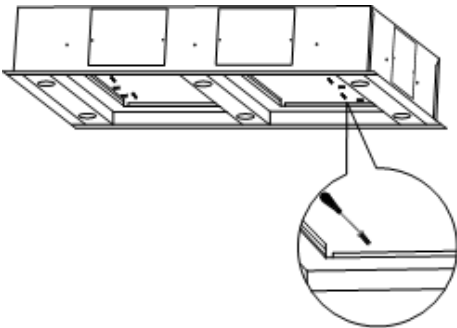

Fig 6

4.2 Ducting Options

The Dusk can be ducted from either the long side, the short side or the back of the hood. On the short side there is one hole central (Fig 7), on the long side there are 2 holes (Fig 8) and on the back there is one hole centrally (Fig 9).

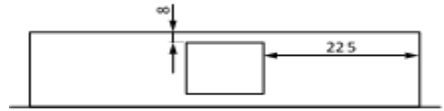

Fig 7

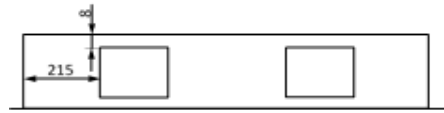

Fig 8

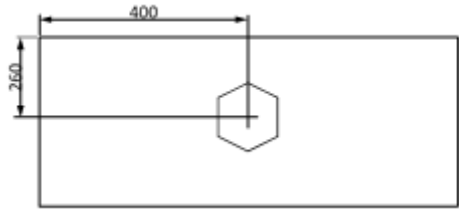

Fig 9

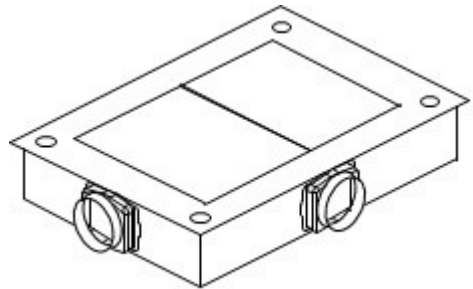

Fig 10

4.3 Motor Options

The Dusk ceiling hood can be fitted with either the 1240 T1 750m³/h motor or the 1250 T2 1400m³/h motor. This can be installed anywhere along the ducting but no more than 6m away.

The motor is fixed to the wall using the L brackets supplied. Screw the motor to the L brackets and attach through A & B points to the wall (Fig 11).

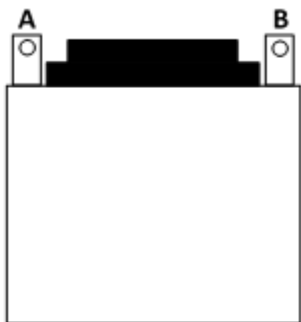

Fig 11

2. Mount the ducting onto the plastic connector of the hood (Fig 12).

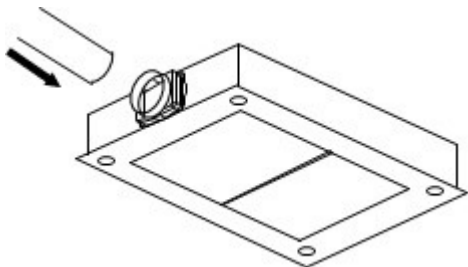

Fig 12

3. Install the ducting work up to the air inlet of the motor (Fig 13).

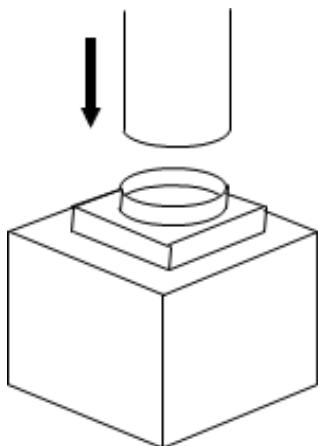

Fig 13

4. Install ducting between the air outlet on the motor and external vent.

4.4 Ducting & Recirculation

Exhaust vs. Circulation

Most extractor systems can be operated either as circulating or exhaust air units. The recommended operating mode depends on various criteria.

Exhaust Air Operation

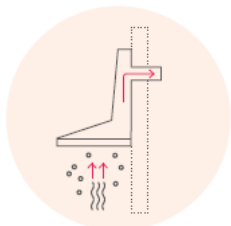

Circulating Air Mode

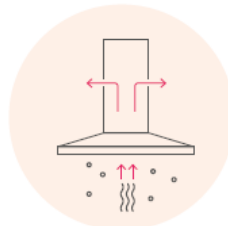

<ul style="list-style-type: none"> The extracted vapour* incl. moisture and odours is led to the outside. 	<ul style="list-style-type: none"> The extracted vapour is filtered and returned to the room.
<ul style="list-style-type: none"> The air volume flow has to be returned to the room by means of suitable measures. 	<ul style="list-style-type: none"> Moisture is not taken away, so this extraction system should provide a basic air exchange in the kitchen.
	<ul style="list-style-type: none"> The removal of odours depends on the efficiency of the filter system, the maintenance condition and the type of domestic ventilation.

* Cooking vapour from water vapour, aerosols and fats

4.4.1 Instructions for Circulating Air Mode

Additional hygienic air exchange required

No moisture loads are taken away in the circulating air mode. According to (DIN 1946-6), an exhaust air volume flow of 40m³/h is recommended to prevent moisture damage. Depending on the size of the kitchen, this corresponds to an air exchange of approx. 0.5 to 2^{h-1}. This can be ensured by a centralised or decentralised ventilation system. If such a system is not available, the basic change has to take place via a manual opening of the windows.

Follow-up Time

A follow-up time of 5-10 minutes for drying the hood system (especially the activated carbon filter) is generally recommended.

Energy Efficiency

In contrast to exhaust air systems, circulating air systems do not require an energy efficiency class. Initial investigations indicate that the quality of the activated carbon filter has a major influence on the energy efficiency of circulating air systems.

Special Features of Countertop Extractors

- In case of a countertop extractor, the vapour is extracted downwards by the system and fed into the base area of the base unit.

- To prevent moisture damage, it is recommended that the circulating air is led out of the base area in a closed air duct system. The circulating air outlets (grilles) must not be obstructed or blocked.
- The recirculation of air into the base area without ducting to the outside of the piece of furniture is expressly not recommended here to potential moisture and mould damage.

Maintenance/degree of Odour Reduction

To ensure that the recirculation filters function properly, they have to be regenerated or replaced at regular intervals in accordance with the manufacturer's recommendations. Users should be informed of the need and follow-up costs. Used circulating air filters have lower degrees of odour reduction. The investigations indicate considerable differences in the activated carbon filter systems.

Pressure Losses/Noise Emission

Circulating air filters represent a high flow resistance and therefore lead to an increased pressure loss. Comparative investigations showed a reduction of the effective volume flow at the hob of up to 25%.

4.5 Recommendations Depending on the Building Standard and Building Equipment

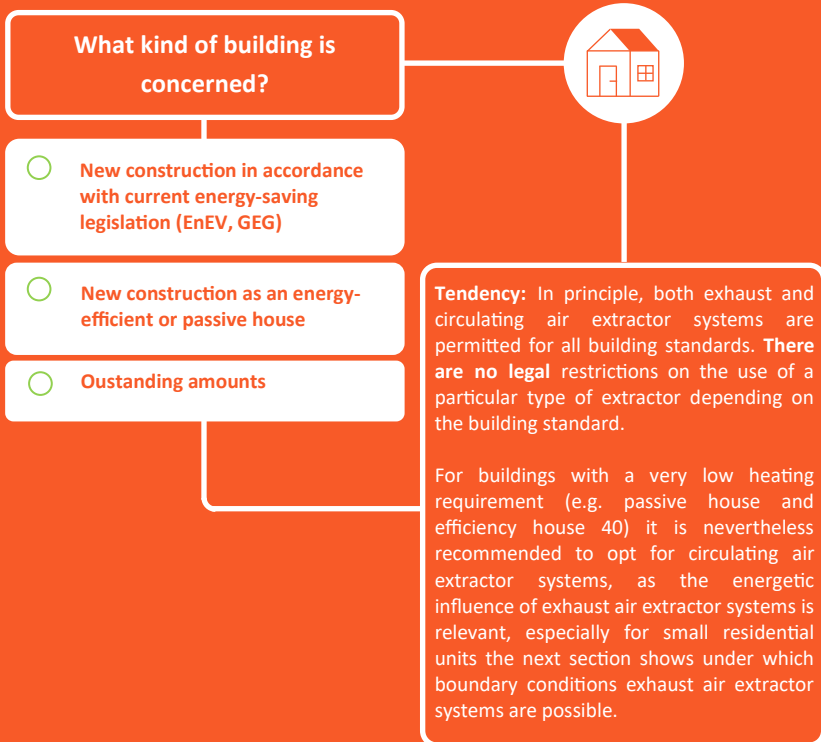



Is a room air-dependent fireplace available or planned (chimney, gas boiler)?

Yes

No

Tendency: If a room air-dependent fireplace is present, it has to be ensured that no negative pressure is generated in the installation room of the fireplace which would allow toxic flue gases to escape. Since a circulating air extractor system does not cause any pressure changes in the building, it can easily be installed in the building. In the case of an exhaust air extractor system, additional technical measures have to be taken to ensure that the negative pressure is limited to 4Pa. These include e.g.:

- Differential pressure switch for common operation
- Automatic supply air opening (position monitor) during common operation
- Alternate operation (safe operation by switching off or optional mode where the system cannot be activated if the room air-dependent fireplace is in operation)

Hint: In buildings with a very low heating requirement, a comfort fireplace of any type is not energy-efficient unless it is the main heat supply system. **Therefore, this point can be neglected in this type of building.**

Is there a ventilation unit?

Yes, a supply air system

Yes, an exhaust air system or a ventilation system in the bathroom

Yes, a supply/exhaust system

No



Tendency: The additional supply air flow for the exhaust fume extraction system has to be independent of the presence of a ventilation system. For reasons of fire protection and hygiene, the kitchen exhaust air extracted via the exhaust air extractor system should not be integrated into an existing air duct. With systems generating a negative pressure (exhaust air system or ventilation system in the bathroom or exhaust air extractor system), the safety-relevant aspect in combination with a room air-dependent fireplace has to be absolutely observed.

How much do the annual ventilation heat losses increase due to the use of exhaust air extractor systems?



For domestic ventilation, a distinction is made between operation with and without heat recovery (heat recovery efficiency 80% or 0%). In ventilation systems with heat recovery, the relative increase in annual ventilation heat losses due to the operation of the exhaust air fume extraction system is much greater. In absolute terms, the annual ventilation heat losses increase by 156 kWh/a to 657 kWh/a due to the operation of an exhaust fume extraction system regardless of the size of the apartment and the presence of heat recovery. This is equivalent to additional heating costs of approx. £9-£46 per year. In the circulating air mode, moisture and non-neutralised odours have to be removed via permanent basic ventilation or window ventilation.

With circulating air extractor systems, on the other hand, additional costs for regular filter changes have to be taken into account. The total costs of both variants are therefore of a comparable order of magnitude.

If **energy-efficient and tight-closing heat retention systems** are used instead of the conventional back draught flaps when using an exhaust fume extraction system, **heat costs are significantly reduced.**

What is the size of the opening for the additional flow in exhaust air systems so that no critical negative pressures can occur in the room?



Extractor systems in the exhaust air mode require an additional air flow, as otherwise negative pressure is created in the kitchen, which is not permitted in conjunction with a room air-dependent fireplace and can lead to critical situations even without fireplaces, e.g. through doors in the air system that can no longer be opened. In general, safety requirements are understood to mean the possible opening of an escape door as a measure against the pressure difference. Critical door opening forces occur in case of a pressure difference higher than 75Pa. It should therefore be ensured that this value is not exceeded in everyday life. The following minimum cross-sections are required for the additional flow in airtight buildings ($n_{50} < 0.6^{h^{-1}}$) in order not to exceed a safety relevant negative pressure of $75Pa^{1*}$

Size of the usage unit	Exhaust air volume flow	Required diameter of free opening area ²
20m ²	250m ³ /h	130mm
	500m ³ /h	180mm
	650m ³ /h	210mm
100m ²	250m ³ /h	100mm
	500m ³ /h	160mm
	650m ³ /h	190mm
200m ²	250m ³ /h	100mm
	500m ³ /h	160mm
	650m ³ /h	190mm

1 Safety-relevant limit value for opening doors. In the case of joint operation with fireplaces, stricter requirements apply with regard to the maximum negative pressure (cf. joint operation with fireplaces).

2 Depending on the design of the after-flow damper and additional pressure losses through the damper blade and cover, the required cross-section may also be significantly higher.

Herd or flock: Is the building listed as a historical monument or are there local building regulations?

Yes

No



Tendency: In the case of listed buildings (preservation order for external façade) or local building regulations that expressly prohibit the alteration of facades (approval required), a circulating air fume extraction system can be installed without further steps. The installation of an exhaust air extractor system has to be approved by the relevant authorities. Discreet exhaust air blinds, some in the colours of the buildings, are available on the market.



Herd or flock: Have moisture or mould damages already occurred in the building?

Yes

No

Tendency: In order to reduce the moisture content in the room air through cooking processes, an exhaust air extractor system is recommended, as this transports the sucked-in moist air to the outside. Recirculating air systems, on the other hand, remove odours through the recirculating air filter, depending on the device, partly to predominantly, but the moisture remains in the room.



Conclusion: In the current version of the Energy Saving Ordinance and the Renewable Energies Heat Act there are no references to a ban on extractor systems, particularly in new buildings with high thermal insulation. Similarly, the electricity requirements of the extractor systems are not currently taken into account in the energy balance for the issue of an energy certificate.

Which type of cooker hood is more suitable depends essentially on both the structural boundary conditions and the user behaviour itself.

4.6 Special Features for Energy-Efficient Buildings



In buildings with a very low heating requirement, such as passive houses and efficiency houses, the use of an exhaust fume extraction system can increase the heating requirement of the utilisation unit.

For example, the following criteria apply to passive houses:

Annual heating requirement
 $<15 \text{ kWh}/(\text{m}^2\text{a})$

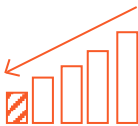

Air tightness of the building envelope
 $n_{50} < 0.6 \text{ h}^{-1}$



The increase in the heating requirement is not only due to the ventilation heat losses during operation of the extractor hood system: if they are not airtight, the exhaust air dampers and the air intake dampers, in particular, can show significant infiltration losses. Airtight sealing products are available on the market.

4.6.1 Recommendations for Buildings with Very Low Heating Requirements

E.g. passive house and efficiency house
40



Circulating air extractor systems are to be preferred from an energetic point of view, taking into account ventilation heat losses and fan power consumption.

Exhaust air extractor systems are possible. The following points have to be observed:

- Solutions for the additional flow are to be provided. The exhaust air opening or air vent opening has to be provided with tightly closing closures. Simple non-return valves are not sufficient.
- Impairments with regard to comfort cannot be ruled out. The aim should be to find solutions that allow the fresh air flowing in to the hob to be introduced in the immediate vicinity of the hob.
- Extractor systems should be used which limit the running time and reset the max. flow rate after a time interval (automatic).
- Preference should be given to systems with moderate exhaust air volume flows to ensure a sufficient capturing. As investigations of capturing vapours have shown, there are considerable differences between the individual products. The air flows required for capturing a defined quantity of vapour differed by up to 60% in the investigated systems.
- In small apartments, the additional ventilation heat loss significantly increases the heating demand and also the heating load. Extractor systems should therefore not be used in such types of buildings if the average size of the flat is less than 90m².

4.7 Ducting

4.7.1 Information on Exhaust Air Ducting

The planning and design of extractor ducting has a significant influence on the airflow rate and the noise level of the cooker hood. This is because each component in the ducting introduces counter pressure (frictional resistance), which leads to a reduction in the airflow rate in the cooker hood and increases the level of noise.

The frictional resistance within the ducting is dependent on a number of factors:

- Cross section of the exhaust air ducting.
- Length of the exhaust air ducting.
- Bends/curves in the exhaust air ducting.
- Material and type of ducting (the material must also be approved for use with a cooker hood in accordance with fire prevention regulations).

4.7.2 Cross Section of the Exhaust Air Ducting

The cross section of the ducting must be adapted to match the airflow rate of the cooker hood and the ducting routing (length and design). A cross section that is too narrow will result in significant losses in the airflow rate and increase noise level. The ventilation performance of the cooker hood is the key factor for determining the ducting cross section. The more powerful the ventilation performance, the greater the ducting cross section must be.

As a rule, the larger the cross section, the less counter pressure is created in the ducting.

The following exhaust air ducting specifications serve as a guide:

- Ø125mm for a ventilation performance of $>400\text{m}^3/\text{h}$
- Ø150mm for a ventilation performance of $<400\text{m}^3/\text{h}$

Any reduction in the cross section of the ducting must be avoided.

This would give rise to turbulence, which would

generate a high amount of counter pressure. The more rapid airflow speed associated with a narrowing in the cross section will also cause the noise level to increase.

TIP

It is only possible to achieve a high airflow volume and low noise level by using extractor ducting that provides low resistance. Always use where possible rigid ducting equivalent to 150mm.

4.7.3 Exhaust Material, Ducting & Shape

FLOW RESISTANCE: LOW

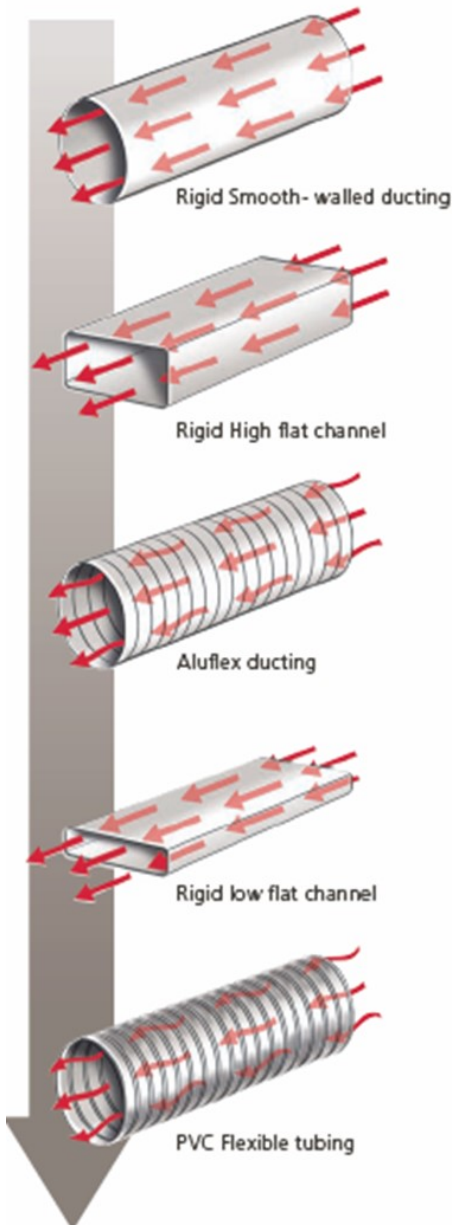

FLOW RESISTANCE: HIGH

Smooth-walled plastic rigid ducts are the most favourable form of ducting from a technical airflow perspective and are particularly suitable for straight duct routes/runs. These should be used if the structural requirements are met.

Flexible aluminium ducting (alu-flux) also achieves reasonably good flow values when elongated. It is more flexible than rigid plastic ducting and adapts well to differing structural conditions.

Unnecessary bends should, however, be avoided.

Corrugated and spiral ducts are the least favourable from a technical airflow perspective. The wave-like surface results in a large amount of turbulence, even if the ducting is pulled taut. When the film is heated by the extracted air, it stretches. This leads to even greater turbulence and the flapping film generates noise. This type of ducting is prone to crushing which will create a poor air flow.

A distinction is made between round and flat channels. Flat channels are often used in practice for both visual and technical reasons. It used to be believed that the flow conditions in flat channels were less favourable. However, this no longer applies as a general rule. Recent developments in flat channels can provide similar or better airflow results than a round channel.

They are characterised by the following features: The inner cross section of the flat channel must correspond at least to the cross section of the exhaust air socket in the cooker hood. The surface area should therefore equate to the cross section of 150mm pipe if the exhaust air outlet has a diameter of 150mm.

The width-to-height ratio must be optimised. The higher the flat channel, the more favourable its airflow qualities (e.g. 90 x 220mm).

4.7.4 Length of the Exhaust Ducting, Curves & Bends

As the length of the exhaust ducting increases, the counter pressure (duct resistance) increases and the airflow rate decreases.

Bends and curves are problematic as they present deflection surfaces that dam the air steam and generate turbulence. This causes an increase in counter pressure. Bends and curves in the ducting should therefore be kept to a minimum. If bends and curves are required for structural reasons, bends with largest possible radius are advisable. The smaller the bend radius, the greater the counter pressure. Corners at right angles should also be avoided if possible because these lead to even greater pressure losses and therefore a loss of performance.

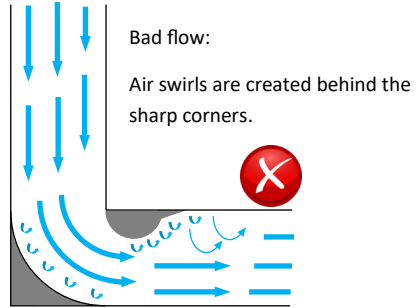
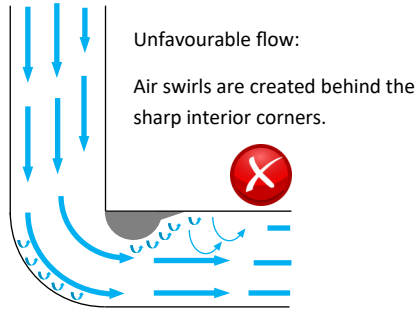
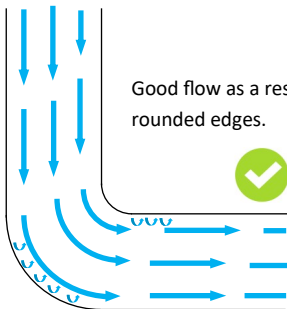
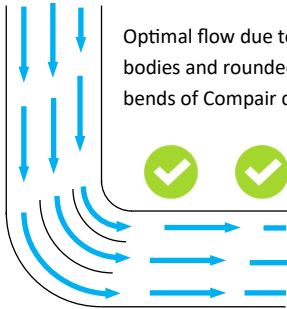

TIP

The following rule of thumb applies for good duct routing:

The distance between two bends should be at least 1m, although 1.5m is better.

The following comparison between different duct types and flat channels indicates the extent to which the material used can influence airflow loss.

COMPARISON BETWEEN CHANNEL SYSTEMS WITH A SQUARE CROSS SECTION

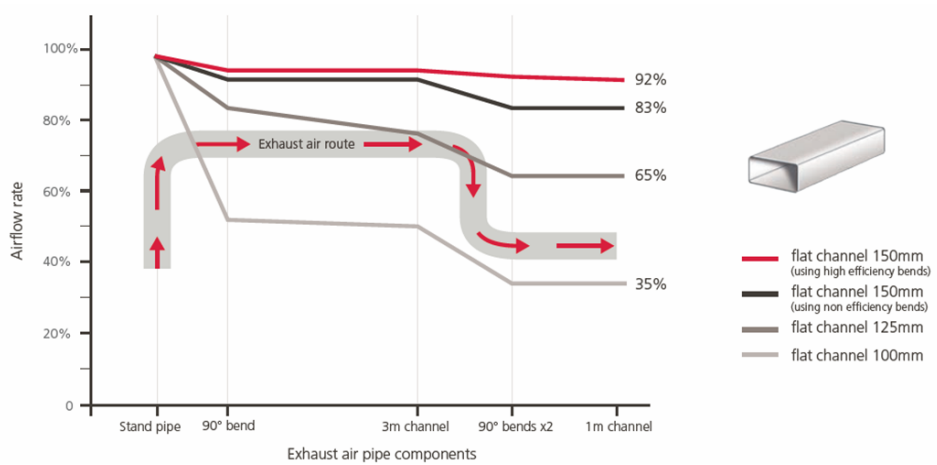

COMPARISON BETWEEN CHANNEL SYSTEMS WITH A ROUND CROSS SECTION

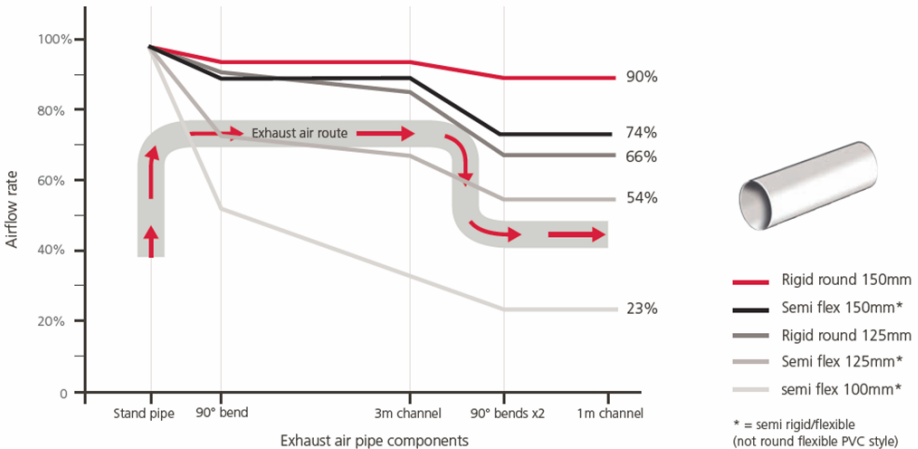

4.8 Electrical Wiring

The electrical wiring must be performed by a specialised electrician fully respecting current standards and legislation in force. **Check that the power supply corresponds to the voltage requested by the hood, which is given on the silver label stuck inside the hood.** Ensure that the wiring system conforms to current standards and the earth discharge works efficiently. Pay special attention to the hood power cable, ensure that it does not pass through any holes without a cable clamp. For direct connection to the electrical mains it is necessary to provide a device that ensures disconnection from the electrical mains, with an opening distance of the contacts that allows the complete disconnection

under the conditions of overvoltage category III, in accordance with the rules of installation. The plug or Omni polar switch must be accessible when the unit is installed.

If the power cord is damaged, it must be replaced by a special cord or assembly available from the manufacturer or its service agent. The cable must be of type H05VV-F 3 x 0.75mm² minimum cross-section.

The manufacturer declines all responsibility if the current accident prevention standards in force are not respected, which are needed for the wiring system to operate correctly.

4.8.1 Electrical Wiring Diagram

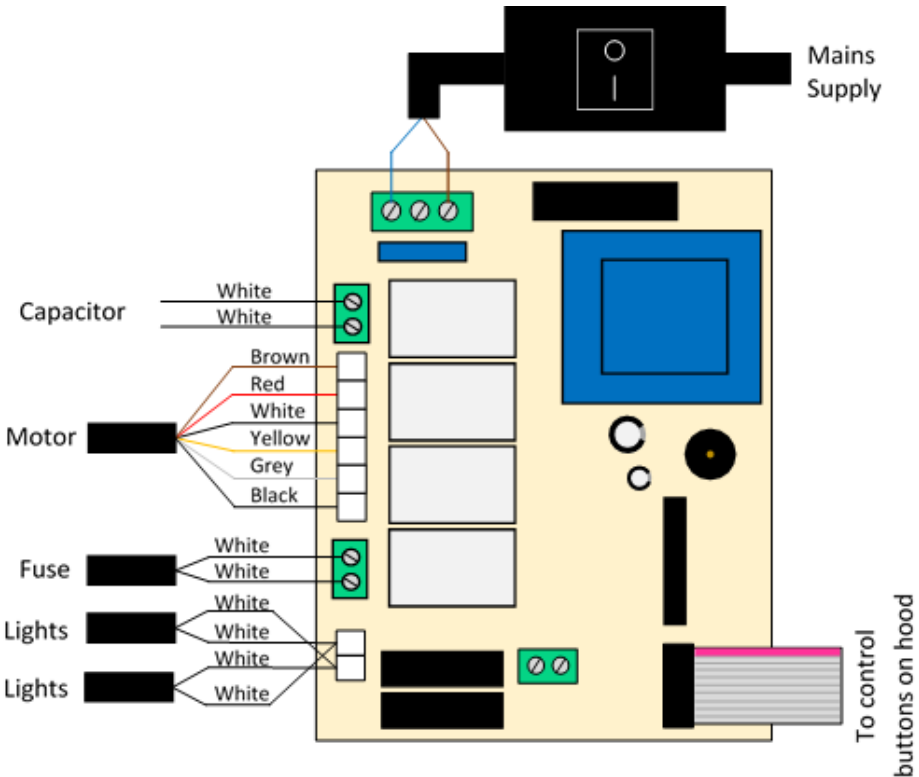





4.8.2 Controls

The Dusk ceiling hood is controlled by remote control. This allows the user to control the hoods on/off functions, lights and 4 motor speeds.



Fig 14

-  Turns the hood on/off at motor speed 2.
-  Increases motor speed.
-  Decreases motor speed.
-  Turns lights on/off.

5. Use & Maintenance

Before beginning any sort of cleaning or maintenance work, turn the power off to the hood by turning the main switch to 0 (OFF).

5.1 Changing the Light Bulbs

To remove light bulb press down on the top of the light bulb holder, unscrew anti-clockwise and pull the light bulb down (Fig 15). Replace with a new one of the same rating (please wait for the light bulbs to cool as they may burn your hand).

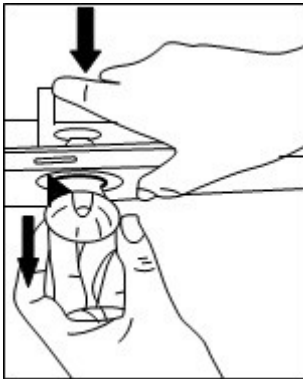

Fig 15

5.2 Cleaning the Metal Filters

The metal filters fitted in the hood should be washed every 2-3 months, depending on how much the hood is used, using hot water and a liquid detergent that is not too aggressive. The metal filters can be removed by the special handle, unhooking the front part of the filter and pulling it downwards (Fig 16).

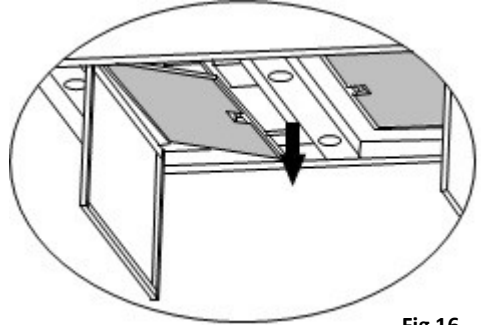

Fig 16

5.3 Cleaning the Hood

The surfaces of the hood should be cleaned frequently, to avoid the risk of having to remove built up and encrusted deposits and stains.

For painted or copper plated hoods just a soft cloth with warm water and a neutral detergent. Do not pour the detergent directly onto the hood or use powdery or abrasive products.

For stainless steel hood, use special products and cloths for satin finish stainless steel (not abrasive, corrosive detergents or detergents containing chloride), ensuring to clean in the same direction as the satin finish.

Do not use aggressive products, chemical solvents or derivatives of oil distillates that could leave oily traces which could cause oxidation and polymerisation.

The manufacturer accepts no responsibility for damage to the surface of the hood due to failure to respect these instructions.

6. Technical Data

Dusk 100cm with 1240 T1 Motor	
Control	Remote Control
Colour/finish	Stainless Steel/White Glass
Lighting	4 x 3W LED Lamps
Airflow (m ³ /h)	175-553
Noise (db)	40-66
Power (W)	165
Voltage (V)	230
Outlet Width (mm)	150
Weight (kg)	34.3

Dusk 100cm with 1240 T1 Motor	
Control	Remote Control
Colour/finish	Stainless Steel/White Glass
Lighting	4 x 3W LED Lamps
Airflow (m ³ /h)	267-721
Noise (db)	46-65
Power (W)	330
Voltage (V)	230
Outlet Width (mm)	150
Weight (kg)	34.3

Dusk 100cm with 1270 T3 Motor	
Control	Remote Control
Colour/finish	Stainless Steel/White Glass
Lighting	4 x 3W LED Lamps
Airflow (m ³ /h)	543-918
Noise (db)	54-72
Power (W)	175
Voltage (V)	230
Outlet Width (mm)	150
Weight (kg)	34.3

7. Dimensions

7.1 Dusk 100cm Ceiling Hood

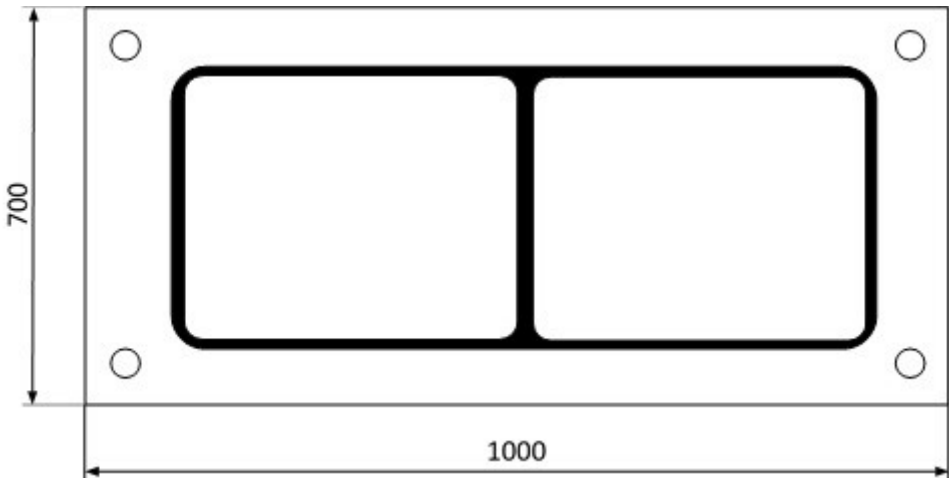

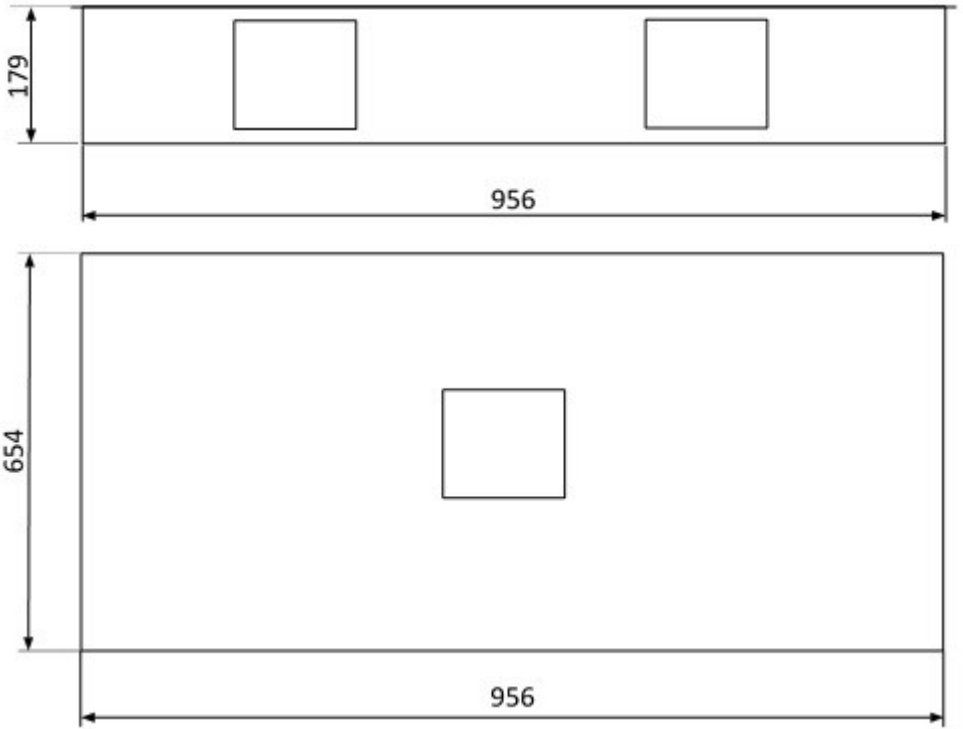

7.2 1240 T1 Motor

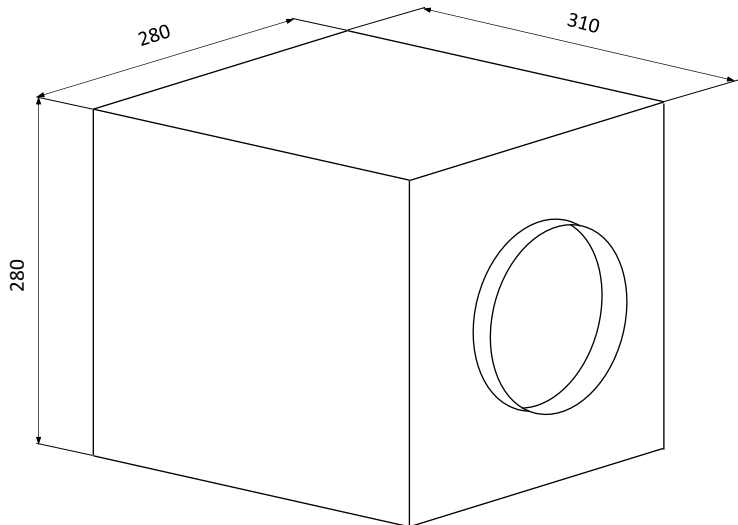

7.3 1250 T2 Motor

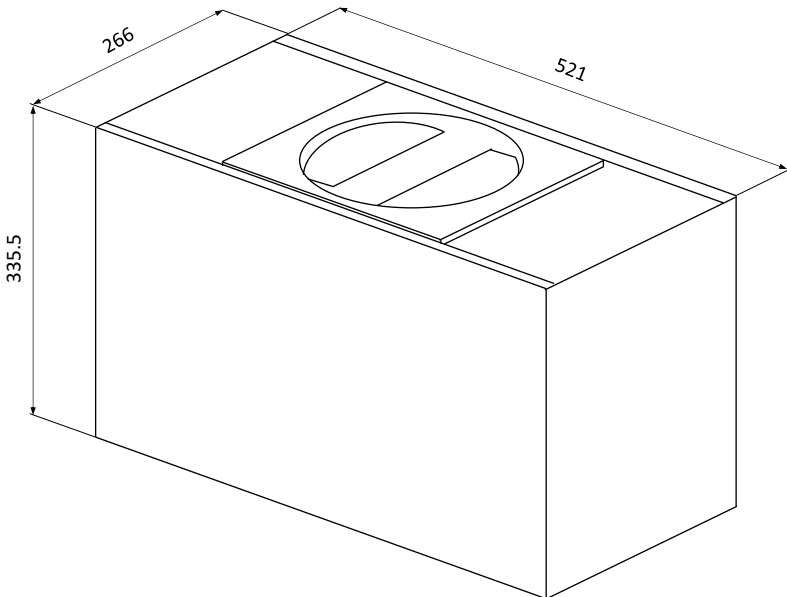

7.4 1270 T3 External Motor

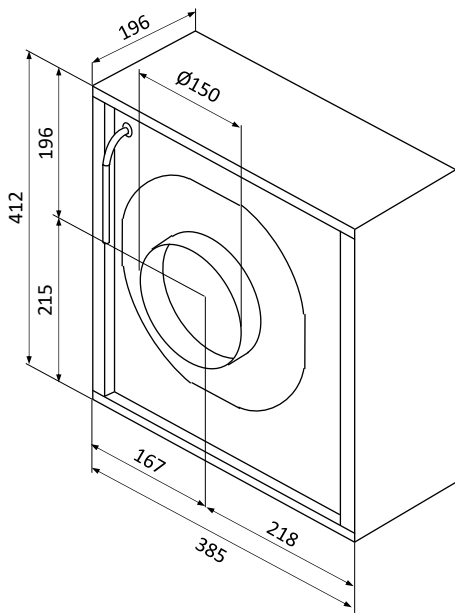

8. Troubleshooting

Please make sure the below has been checked before logging a service call.

NOISY

- Check that the hood has correct size ducting (semi or rigid ideally).
- Make sure there are no restrictions within the ducting outlet.
- Make sure the minimum amount of 90 degree bends have been used.
- Make sure the hood has been secured to the wall correctly as per instructions (fixing screws used to secure).
- Make sure cable hasn't been dropped into fan area.
- Make sure back draught flaps have not been jammed semi closed against ducting.
- In re-circulation mode make sure the flue vents/grilles are not covered.

POOR EXTRACTION

- Check that the hood has correct size ducting (semi or rigid ideally).
- Make sure there are no restrictions within the ducting outlet.
- Make sure the minimum amount of 90 degree bends have been used.
- Make sure back draught flaps have not been jammed semi closed against ducting.
- Make sure ducting doesn't exceed recommended length run for the model installed.
- Make sure customer is switching hood on 10 minutes before cooking and leaving on 10-15 minutes after.
- Advise customer to always reduce boiling water to simmer and use lids.
- On recirculation mode it is more important to use lids on pots and pans to reduce steam/humidity in room.

